

Flat surface grinding	Internal grinding	Cylindrical grinding	Gear and thread grinding	Tool grinding
Saw sharpening	Rough grinding	Rail grinding	Specification	

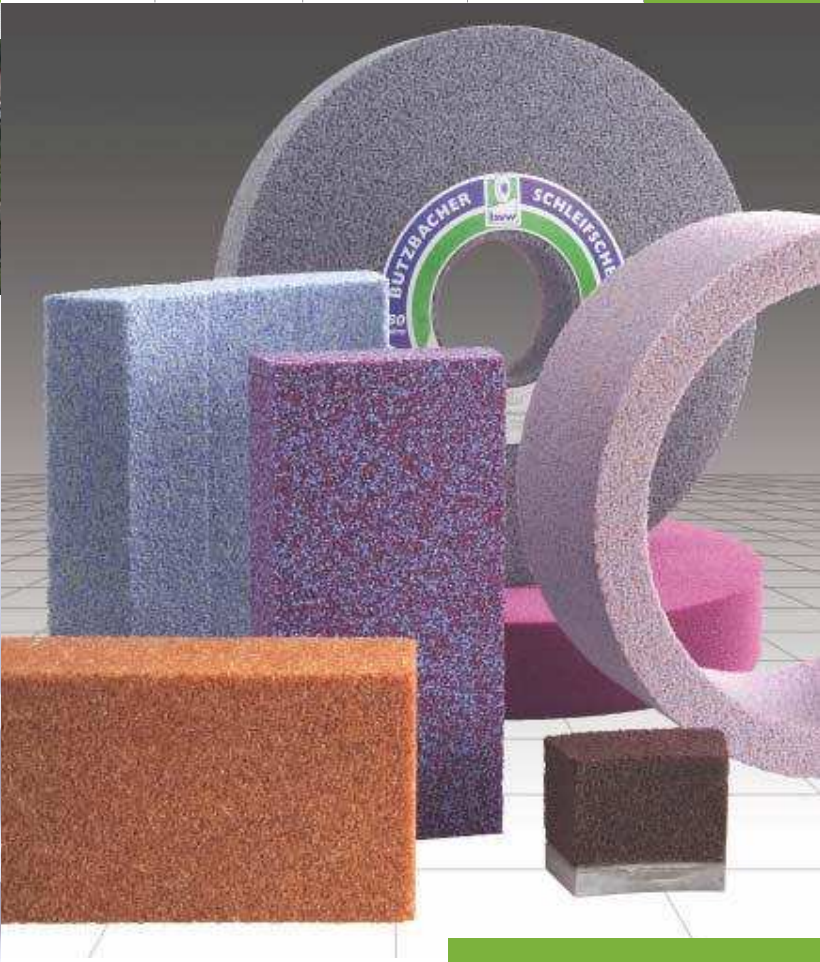

**Butzbacher Schleifmittel-Werke GmbH**  
 Wetzlarer Straße 42  
 35510 Butzbach / Germany  
 Telefon: +49 (0) 60 33 / 89 05 - 0  
 Telefax: +49 (0) 60 33 / 89 05 - 13  
 e-mail: [service@butzbacher.de](mailto:service@butzbacher.de)  
 Internet: [www.butzbacher.de](http://www.butzbacher.de)



**Abrasive systems for optimal production processes**



**Butzbacher grinding wheels**



**Butzbacher grinding wheels**



... far from the usual grind

... far from the usual grind



Flat surface grinding	Internal grinding	Cylindrical grinding	Gear and thread grinding	Tool grinding
Saw sharpening	Rough grinding	Rail grinding	Specification	

With 70 employees in our modern factory in Butzbach, our main focus is on small and medium-sized companies in the mechanical engineering, rolling bearing industry, automotive supplying industry,

# Quality and innovation



machine and tool construction, manufacturers of precision tools, steel and rolling mills, iron and steel foundries, gear and spring industry and timber, glass and plastics industry. Products from "Butzbacher Schleifscheiben" make our customers more competitive due to their excellent grinding performance and lower grinding costs.

Our products cover the entire production grinding of mostly hard, ductile and alloyed steel tools as well as rough to fine and precision grinding. Our high-tech bonds are the basis for high performance precision grinding and ensure



- We achieve this high quality through systematic and computer-supported compositions
- digital weighing devices for weighing abrasive and bonding materials
  - special ceramic mixers for homogeneous mixtures
  - digital weighing of the mixture into the moulds
  - NC controlled presses with an accuracy of up to 0.005 mm
  - digitally controlled dry processes
  - digitally controlled firing processes
  - final machining on NC lathes
  - final inspection on digital balancing scales
  - constant monitoring of production with documentation of measured values

Today we can claim with pride to be one of the most modern manufacturers of abrasives worldwide and can offer our customers, in addition to tailor-made product development concepts, 70,000 standard products in 12,000 different compositions, forms and special forms such as cylinder wheels, cup wheels,



Quality, innovation, reliability, flexibility and speed: This is what we offer our customers on a daily basis. We have specialised in the development and manufacture of grinding and abrasive wheels for over 85 years.

With our products, we make a valuable contribution to optimising customer-specific

production processes, where customer satisfaction comes first. "Butzbacher Schleifscheiben" are highly regarded worldwide. As a developer and manufacturer of high-quality grinding wheels, we are committed to meeting specific customer requirements.

excellent profile and geometrical stability as well as high stock removal rates.

All of our products conform to current standards and internationally recognised FEPA grain standards. Intensive dialogue with customers and machine manufacturers forms the basis for providing tailor-made solutions

quickly and efficiently. Our highly modern production facilities enable us to offer products of the highest quality with precise repeat accuracy and high flexibility in production and delivery. We can deliver specific products and individual abrasives within four weeks - where other suppliers need double the time.

(straight and flared), dish grinding wheels, grinding segments in a wide range of shapes and sizes, whetstones, abrasive cutting-off and roughing wheels, cylindrical grinding wheels and internal grinding wheels.

Flat surface grinding	Internal grinding	Cylindrical grinding	Gear and thread grinding	Tool grinding
Saw sharpening	Rough grinding	Rail grinding	Specification	

# Service and closeness to customers



As an individual system supplier, we offer a wide manufacturing programme with diverse dimension and application-related special solutions. Our engineers precisely adapt the composition of the abrasive wheel to suit specific customer requirements.

The use of high-quality abrasive materials from quality-orientated suppliers is a basic precondition for supplying quality products, whereby the abrasive materials are subject to constant and stringent incoming inspections to high standards.

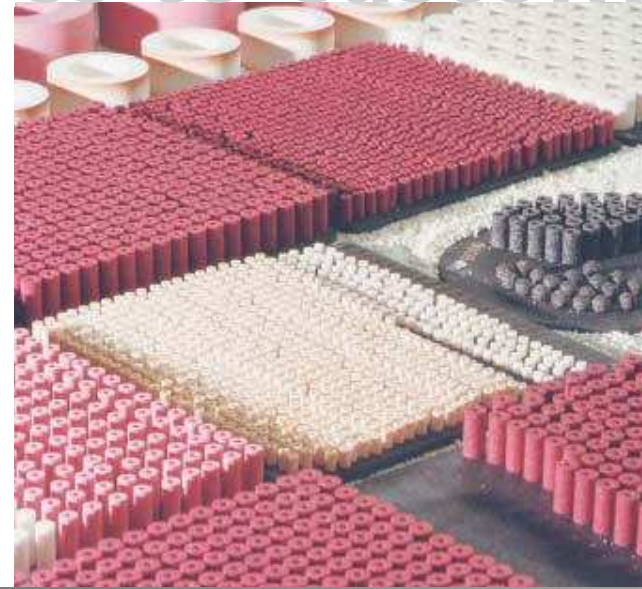

Our primary aim with these products is to provide our customers with more cost-effective and specific performance, where optimal grinding, surface quality and tolerance are tailored to suit individual customer requirements.



Our range of services includes competent, individual advice and extensive customer service.

The importance we attach to our closeness to customers internationally is reflected in our representatives in Holland, Scandinavia, Spain and Portugal, Middle East, Pakistan and Malaysia.

We strive to continuously improve our products in line with constantly changing market requirements with an experienced team of engineers and a highly modern development department.

Our in-house test laboratory enables practice-orientated grinding operations to be carried out on various grinding

machines before new or improved products are introduced to the market. Product developments in a variety of compositions and dimensions, with vitrified or resinoid bond, are tested under production conditions and rendered suitable for all machines and applications. Whether for precision grinding, rough grinding, tool

grinding, form grinding or fine grinding.

"Butzbacher Schleifscheiben" offer a wide range of products with exclusive innovations geared to market and customer requirements for their large customer base in numerous branches of industry.



Flat surface grinding	Internal grinding	Cylindrical grinding	Gear and thread grinding	Tool grinding
Saw sharpening	Rough grinding	Rail grinding	Specification	

# Reliability through abrasive material quality



## Regular aluminium oxide

Particularly tough grain, low tendency to chip, fractures blocky. Regular aluminium oxide has a long lifespan, however cool grinding is not possible. Regular aluminium oxide is used mainly for roughing, cleaning and deburring unhardened and hardened-and-tempered steels, forging grade steel, ingot steel and soft iron, steel, grey cast iron and malleable cast iron for manual and machine grinding. Modern grinding wheels in various grain combinations are also used.

## Semi-friable aluminium oxide

Semi-friable aluminium oxide does not have the toughness and compressive strength of regular aluminium oxide, but chips more pointed. It is suitable for a wide range of applications that extend from

of special fused aluminium oxide can be influenced by the addition of titanium or chrome oxide in various percentage amounts, i.e. it becomes tougher. White, pink and ruby special fused aluminium oxide can be used for almost all materials.

## Monocrystalline aluminium oxide

Monocrystalline aluminium oxide is obtained by a different fusion process. The chipping behaviour of the monocrystalline aluminium oxide is similar to that of dark silicon carbide. Monocrystalline aluminium oxide has firm cutting edges and high compressive strength. The most important applications are the grinding of high-alloyed steels and grinding operations with high geometrical and dimensional accuracy. It is also often used

reduced to that for conventional grinding wheels, sintered aluminium oxide produces optimal grinding results, and low peak-to-valley roughness does not pose a problem. The lifespan of a sintered aluminium oxide grinding wheel can be much longer than that of other conventional wheels (special fused aluminium oxide, silicon carbide), but it costs only about 1.5 to 3 times more. It can even be used on extremely hard tool steels with astounding results. However, the performance of CBN is unattainable. Economic substitution of CBN is possible in many cases for individual components or small piece numbers.

## Silicon carbide

Compared to corundum, silicon carbide is harder, but not

## Light green silicon carbide

This abrasive is extremely aggressive and due to its special chipping characteristic, which can be described as "sharp edged and pointed", is used where material hardness and/or elongation are typical characteristics. With respect to the hardness, light green silicon carbide is still regarded as the best substitute for diamond for cost-efficiency reasons.

## Dark silicon carbide

This abrasive is extremely hard, but much less brittle than the "green version". It chips blocky, comparable with regular aluminium oxide, whereby in comparison to the latter, sharp edges are produced. This gives dark silicon carbide its typical properties.

Modern vitrified low-firing bonds play an important role. They are produced synthetically in the majority of cases and reach their hardness and strength already at oven temperatures of up to about 950°C. They were developed specifically for the vitrified bonding of diamond, CBN and sintered aluminium oxide. At higher firing temperatures, these abrasives would be destroyed (oxidised) or – in the case of sintered aluminium oxide – fused to lumps, having virtually no ability to chip.

All bonds used by BSW have been developed in-house and are not available from any other manufacturers.

Abrasive grain and bonding material are the basic elements of all our products, whereby the main focus is on the high quality and reliability of these materials. We do not obtain any abrasive materials from the Far East, because we put our trust in our European

suppliers. We do not compromise on our vitrified and resinoid bonds: All bonds are developed in our laboratory and tested in our test department for suitability for series production.

rough grinding through to precision grinding.

## Special fused aluminium oxide white, pink, ruby

Of all grain types, special fused aluminium oxide has the highest tendency to chip. White special fused aluminium oxide is particularly suitable for hardened steels and therefore used mainly for precision grinding. The fracturing characteristics

in combination with other abrasive grain types.

## Sintered aluminium oxide

Sintered aluminium oxide has a property that is not common to other grain types: It does not become blunt! Depending on the external load on the grinding wheel, various sized grain particles chip off in use, immediately exposing sharp-cutting tips. When the dressing infeed is

as tough. It is therefore suitable for grinding the following materials:

- All types of glass, ceramic, stone, partly also engineering ceramics
- Aluminium, copper, bronze, brass
- High-alloyed, hardened steels (tool steels), nitrided steels
- Malleable cast iron and cast steel
- Hard metals in a sintered and hardened state

## Bonds

Apart from the abrasive grain, the bond is one of the most important elements of a grinding tool. The bond holds the abrasive grains together in a very special way, which influences and controls the grinding properties to a large extent. Very dense, but also very open structures with numerous pores can be produced.



Flat surface grinding	Internal grinding	Cylindrical grinding	Gear and thread grinding	Tool grinding	Flat surface grinding	Internal grinding	Cylindrical grinding	Gear and thread grinding	Tool grinding
Saw sharpening	Rough grinding	Rail grinding	Specification		Saw sharpening	Rough grinding	Rail grinding	Specification	



## Flat surface grinding

Whether grinding takes place with grinding wheels, cup wheels, cylinder wheels or grinding segments (with or without holders) – from regular aluminium oxide to sintered aluminium oxide with vitrified or resinoid bond: The main emphasis is on optimal grinding performance. Our grinding tools offer exceptional properties with excellent cutting action, self-sharpening effect, low cutting temperature and maximum dimensional stability. Our wide range of products provide for a broad spectrum of applications for precision grinding machines with transverse or rotary table – using pendulum or full-width grinding. Our low cost standard range of products covers the materials described opposite – through to highly porous sintered aluminium oxide grinding tools for hard tool steels. We produce grinding segments in virtually all standard forms. We carry holders for disc grinding machines in stock.

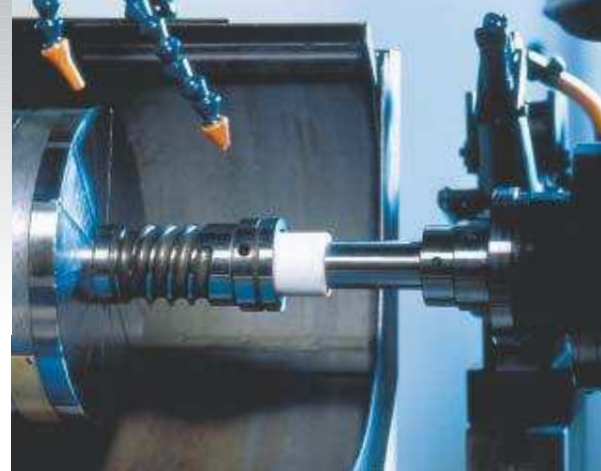

## Internal grinding

We manufacture internal grinding wheels from 5 mm to 150 mm diameter to suit individual customer requirements. Our standard range of products, constantly carried in stock, covers a wide range of grinding applications. Despite their partly small size, internal grinding wheels must be fully developed solutions that are tailored to specific grinding applications. Particularly with very small dimensions, grinding precision is key. High stock removal rates, cool grinding and easy cutting action – these are the outstanding features of our products. With or without shaft, with or without recess – we manufacture to your specifications in small lot sizes.



### Wheel types:

Type 1: Straight grinding wheel  
D x T x H

Type 2: Cemented Grinding cylinder  
D x T x H or D x T x W

Type 5: Grinding wheel recessed on one side  
D x T x H – P x F

Type 6: Straight Cup wheel  
D x T x H – V x E

Type 7: Grinding wheel recessed on both sides  
D x T x H – P x F/G

Type 20: Grinding wheel relieved on one side  
D/K x T/N x H

Type 21: Grinding wheel relieved on both sides  
D/K x T/N x H

Type 22: Grinding wheel relieved on one side and recessed on opposite side  
D/K x T/N x H – P x F

Diameter	Width	Hole
225	20, 25	32, 50, 8, 76, (2)
250	13, 16, 20, 25	50, 8, 76, (2)
300	13, 16, 20, 25, 32, 40, 50	76, (2), 127
350	16, 20, 25, 32, 40, 50	76, (2), 127
400	20, 25, 32, 40, 50, 63, 80, 100	127, 203, 2
450	20, 25, 32, 40, 50, 63, 80, 100	127, 203, 2
500	25	203, 2
500	32, 40, 50, 63, 80, 100	203, 2, 304, 8
600	32, 40, 50, 63, 80, 100, 125	203, 2, 304, 8
750	30 – 125	304, 8
800	31 – 125	304, 8
900	32 – 125	304, 8
1060	32 - 160	304, 8

### Wheel types

Type 1: Straight grinding wheel  
D x T x H

Type 5: Grinding wheel recessed on one side  
D x T x H – P x F

Diameter	Width (recess)	Hole
10	10	4
13	13 (6x6)	4
16	16 (10x4)	6
20	20 (13x8)	6
25	16 (16x6)	10
25	25 (16x10)	10
32	20 (16x8)	10
32	32 (16x12)	10
40	25 (20x10)	13
40	32	13
40	40 (20x15)	13
50	32	20
50	40 (32x15)	20

**All recesses optional!**

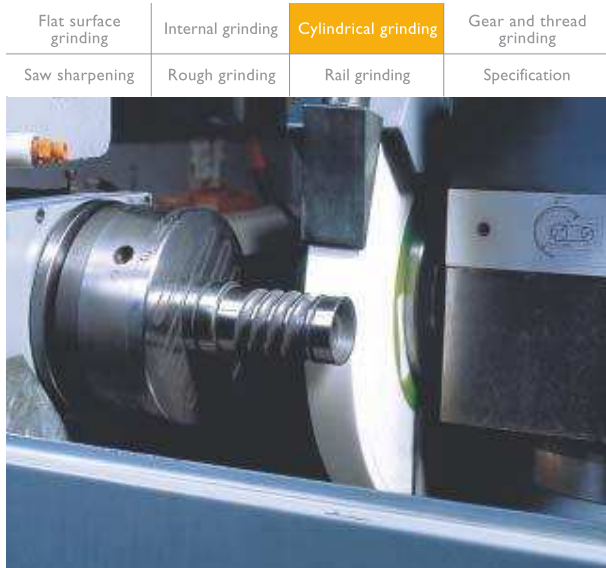

## Cylindrical grinding

BSW offers an extensive range of products for cylindrical grinding. Our products are designed to ensure excellent cooling in the grinding contact zone and offer for this application all conceivable solutions also for pendulum grinding, plunge-grinding and centreless grinding. Our grinding tools provide a number of special advantages such as high stock removal rates, high self-sharpening effect and extended dressing intervals.

Profile stability, performance and time are the factors that contribute to an optimal grinding process. We can help you to actively reduce your piece costs!



## Gear and thread grinding

Pre-profiled for Reishauer-Maschinen, bevelled on both sides (e.g. for Höfler, Niles, Pfauter, etc.) or for MAAG: We manufacture all of these grinding wheels. We are fully aware of the difficult and high requirements of gear manufacturers and have the means to comply with these requirements. With our diverse selection of abrasive materials, we can provide the right grinding wheel to suit your particular application. Whether for full profile grinding, generating grinding or spiral bevel gear grinding, we offer the highest precision. Our fine-

grained wheels minimise the risk of overheating when grinding due to special bond concepts and optimal cooling as well as surface damage. For the ground thread, this means less wear and greater performance. Our sintered aluminium oxide grinding wheels are provided with just the right amount of sintered aluminium oxide necessary for the particular grinding operation. This reduces purchasing costs and protects dressing tools. Our grinding tools are synonymous with the highest precision and reliability!



### Wheel types

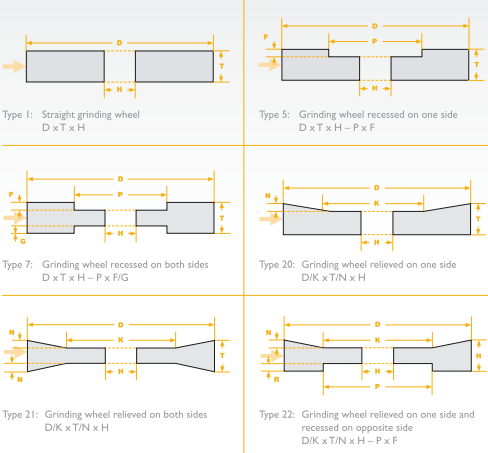

...as well as all standard wheel faces.

Diameter	Width	Hole
225	20, 25	32, 50, 8, 76.2
250	13, 16, 20, 25	50, 8, 76.2
300	13, 16, 20, 25, 32, 40, 50	76.2, 127
350	16, 20, 25, 32, 40, 50	76.2, 127
400	20, 25, 32, 40, 50, 63, 80, 100	127, 203.2
450	20, 25, 32, 40, 50, 63, 80, 100	127, 203.2
500	25	203.2
500	32, 40, 50, 63, 80, 100	203.2, 304.8
600	32, 40, 50, 63, 80, 100, 125	203.2, 304.8
750	30 - 125	304.8
800	31 - 125	304.8
900	32 - 125	304.8
1060	32 - 160	304.8

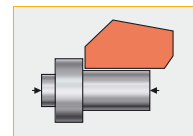

Angular plunge-cut

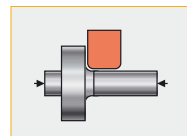

Grind shoulder with radius

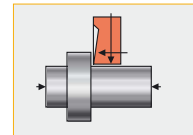

Face-grind shoulder

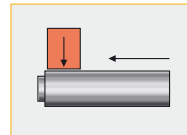

Oscillating

### Wheel types

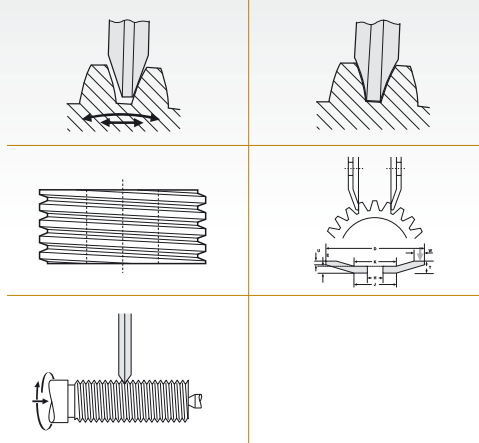

Reishauer		
Diameter	Width	Hole
350	62, 84, 104	160
400	84, 104	160
with div. modules, 1 or 2-thread		

Pfauter Kapp, Hoefler, Niles, Reform, Samputensili		
Diameter	Width	Hole
350	25 - 63	127
400	25 - 63	127, 203.2
450	25 - 63	127, 203.2

Thread grinding		
Diameter	Width	Hole
350	8 - 16	160

Flat surface grinding	Internal grinding	Cylindrical grinding	Gear and thread grinding
Saw sharpening	Rough grinding	Rail grinding	Specification

<b>Tool grinding</b>
----------------------

Flat surface grinding	Internal grinding	Cylindrical grinding	Gear and thread grinding
Saw sharpening	Rough grinding	Rail grinding	Specification

Tool grinding
---------------



## Tool grinding

Optimal performance in normal tool grinding practice is important for any company. The precision and lifespan of ground cutting tools is largely influenced by the quality of initial grinding as well as subsequent grinding. Because the tools to be ground are exposed to considerable mechanical, thermal and chemical loads, it is important that these are minimised by using suitable abrasives. This has a significant effect on tool operation with regard to cutting quality in the production process, tool service life and the overall efficiency of the production process.

BSW offers an ideal range of abrasive products for hard, high-alloyed tools (milling cutter, turning tools, hob cutters and drills) with high-performance sintered aluminium oxide qualities. The grinding performance is high, the grind cool and the lifespan long.



## Saw sharpening

We stock the right grinding wheels for band, circular and chain saws, production and reworking, wet and dry grinding! Stellite tipped saw blades and CV or HSS metal saws can be ground with maximum precision. Our saw sharpening wheels with sintered aluminium oxide have shown to be highly reliable. These wheels are characterised by a long lifespan, excellent dimensional stability and cool grind.

In addition, saws perform better and have a longer life. Our grinding wheels have been designed for a cutting speed of up to 63 m/s and are therefore ideal for variable-speed spindle drives. Grinding wheel performance can be noticeably increased as a result. Our range of accessories include suitable dressing tools as well as further grinding tools for other grinding applications, e.g. profile knives.



### Wheel types

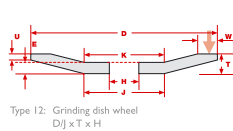
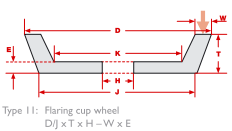
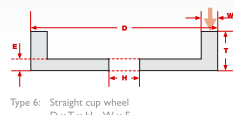
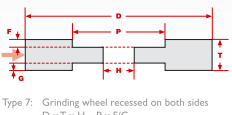
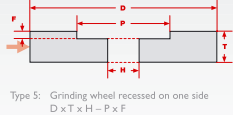
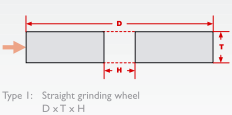

### Type 1 - straight

Outside-Ø	Thickness	Hole
125	20	32
150	20, 25	32
175	20, 25, 32	32, 51
200	20, 25, 32	32, 51
250	32	32, 51
300	40	32, 51, 76

### Type 6 - DIN D

Outside-Ø	Thickness	Hole
80	40	20
100	50	20
125	63	20, 32
150	80	20, 32

### Type 11 - DIN E

Outside-Ø	Thickness	Hole
100	35, 40	20
125	40, 45	20, 32
150	50	20, 32

### Type 12 - DIN B

Outside-Ø	Thickness	Hole
80	8	20
100	12	20, 32
125	14	20, 32
150	15	20, 32

### Edge types

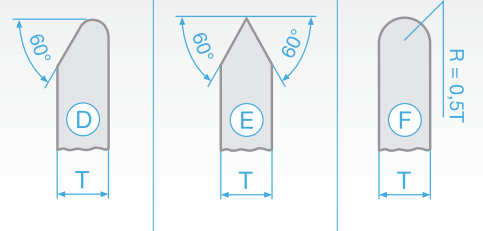

### Chain saws

Diameter	Width	Hole
140 - 150	3 - 4,8	16, 20, 25, 32

### Circular saws, band saws

Diameter	Width	Hole
150, 200, 250	1 - 16	20, 25, 32

### Resinoid

Diameter	Width	Hole
150, 200, 250	1 - 14	20, 25, 32
300	10 - 14	32, 40

Flat surface grinding	Internal grinding	Cylindrical grinding	Gear and thread grinding	Tool grinding	Flat surface grinding	Internal grinding	Cylindrical grinding	Gear and thread grinding	Tool grinding
Saw sharpening	<b>Rough grinding</b>	Rail grinding	Specification		Saw sharpening	Rough grinding	<b>Rail grinding</b>	Specification	



## Rough grinding

We have been suppliers to the metalworking industry as well as manufacturers of castings and foundries at home and abroad for decades.

Our production programme includes resinoid bonded grinding mounted points and grinding wheels with diameters from 20-750 mm.

We also supply grinding wheels with diameters above 900 mm for grinding steel and cast-iron rolls. Our products are highly regarded and used due to their exceptional grinding properties, durability and, not least, due to their safety reser-

ves. For foundries, we produce high-speed grinding wheels up to 80 m/s with sufficient safety reserves. For over 85 years we have developed for all of these applications a fully developed range of grinding and polishing wheels in diverse materials, sizes, geometrical shapes and qualities. Whether for rough grinding, form grinding or to achieve surfaces suitable for galvanising, deburring, descaling or tough structuring and burnishing.



## Rail grinding

For modern rail vehicles, a good rail profile is more important today than ever before: Minimum rolling resistance, smoothness of running, high wear resistance and large safety reserves are the demands placed on the rail material. BSV has taken this into account with the development of optimal grinding tools specifically for this purpose.

We produce for virtually all grinding machines, grinding tools ...

- unique resinoid bonds – specially for grinding rail steel

- up to 80 m/s peripheral speed with glass fabric reinforcement
- for almost all standard machine types with special thread
- excellent grinding performance also on hot and cold rails with only one wheel
- sufficient safety reserves for maximum loads
- exceptional surfaces without edge damage
- extremely long lifespans – resulting in reduced costs

And also:  
Manufactured 100% by us!

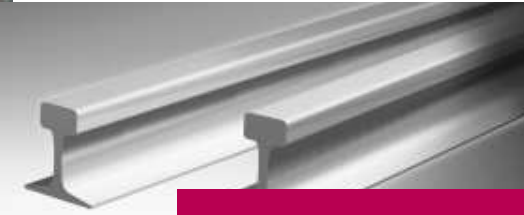

### Wheel types

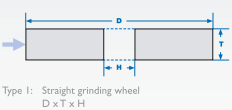

Type 1: Straight grinding wheel  
D x T x H

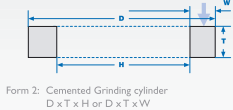

Form 2: Cemented Grinding cylinder  
D x T x H or D x T x W

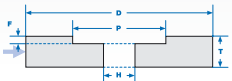

Type 5: Grinding wheel recessed on one side  
D x T x H – P x F

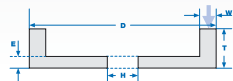

Type 6: Straight cup wheel  
D x T x H – W x E

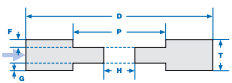

Type 7: Grinding wheel recessed on both sides  
D x T x H – P x F/G

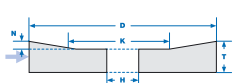

Type 20: Grinding wheel relieved on one side  
D/K x T/N x H

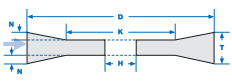

Type 21: Grinding wheel relieved on both sides  
D/K x T/N x H

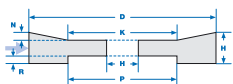

Type 22: Grinding wheel relieved on one side and recessed on opposite side  
D/K x T/N x H – P x F

Diameter	Width	Hole
225	20, 25	32, 50, 8, 76 (2)
250	13, 16, 20, 25	50, 8, 76 (2)
300	13, 16, 20, 25, 32, 40, 50	76 (2), 127
350	16, 20, 25, 32, 40, 50	76 (2), 127
400	20, 25, 32, 40, 50, 63, 80, 100	127, 203.2
450	20, 25, 32, 40, 50, 63, 80, 100	127, 203.2
500	25, 40, 50	127, 150
500	32, 40, 50, 63, 80, 100	203.2, 304.8
600	32, 40, 50, 63, 80, 100, 125	203.2, 304.8
750	30 – 125	304.8
800	31 – 125	304.8
900	32 – 125	304.8
1060	32 - 160	304.8

### Wheel types

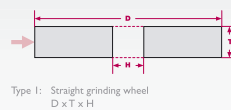

Type 1: Straight grinding wheel  
D x T x H

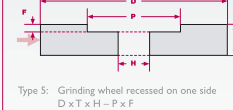

Type 5: Grinding wheel recessed on one side  
D x T x H – P x F

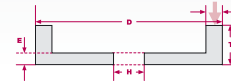

Type 6: Cylindrical grinding cup with centre thread  
D x T x H – W x E

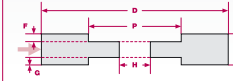

Type 7: Grinding wheel recessed on both sides  
D x T x H – P x F/G

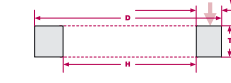

Type 2: Cemented Grinding cylinder grinding cylinder with threads  
D x T x H or D x T x W

Diameter	Width (recess)	Hole
110/90	55 (HT110)	22,2
125	60 (with 4 threads MB)	55
125	65 (with centre thread M20)	M20 R/L
135	90 (recess 55x30)	25,5
150	60 (with centre thread M20)	M20 R/L
150	65 (with 4 threads MB)	80
150	70 (with centre thread M20)	M20 R/L
200	80 (with 4 threads MB)	130
230	20, 23, 25, 30	25
250	20	25,4
254	32 (with recesses)	25,4
260	25	120
300	40	120



Flat surface grinding	Internal grinding	Cylindrical grinding	Gear and thread grinding	Tool grinding	
Saw sharpening	Rough grinding	Rail grinding	Specification		

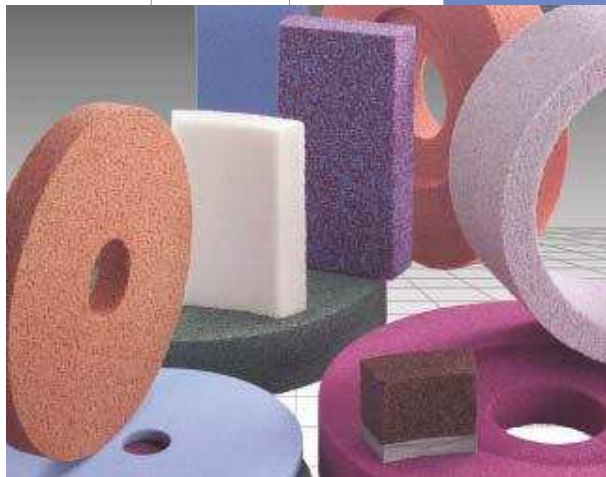

## The "right" choice

Choosing the optimal combination of abrasive grain, grain size, hardness, structure and bond is decisive for maximum grinding performance!

We have access to all abrasive materials available on the market and combine these with our wide bandwidth of different bond types developed by us. With our decades of experience, you can trust us to

find the right composition for your specific application. We do not recommend the lowest cost variant, but a solution that ensures successful results. With our own composition system, we can modify any composition to suit individual requirements.



# New dimensions in performance through standard-setting product innovations

To give you a free choice of materials for your products and tools, we have recently developed several innovative products and further improved successful products. In doing so, our product developers have set new standards in many respects and put our claim of optimal function and customer benefits into practice in uniquely competitive products.



### Designations

(according to international standard DN ISO 12413)

Conventional abrasives	Grains	Degree of hardness	Structure	Bonds
10A / 12A Regular aluminium oxide	10,12,14,16 very coarse	C, D extremely soft	3-5 dense	V (vitrified)
18A Regular aluminium oxide/zirconium aluminium oxide	20,24,30,36 coarse	E, F very soft	6-8 medium	V10
19A Regular aluminium oxide/zirconium aluminium oxide	46,54,60,70,80 medium	G, H, I, J soft	9-10 open	V20
20A Half special fused aluminium oxide	90 and fine fine	K, L, M medium hard	11-20 very open	V25
30A Special fused aluminium oxide, white	240 and fine very fine	N, O, P, Q hard		V28 blue
31A Regular/special fused aluminium oxide, white		R, S, T very hard	..1...2 highly porous	V31 orange
40A Special fused aluminium oxide, pink			..3 medium porous	V341 red
50A Ruby aluminium oxide				V625 blue
51A, 81A Monocrystalline aluminium oxide				V635 blue
517A, 518A Monocrystalline/special fused aluminium oxide				V655 blue
55A Ruby/monocrystalline aluminium oxide				V735 blue
60C Silicon carbide, green				
66C, 68C Silicon carbide, dark				B (resinoid)
3A Sintered aluminium oxide mixture				BF Fibre reinforced
7.A Mixture of sintered aluminium oxides and special fused aluminium oxides				
8.A Mixture of sintered aluminium oxides and special fused aluminium oxides				
9.A Mixture of sintered aluminium oxides and special fused aluminium oxides				

**All compositions not shown here consist mostly of mixtures of the aforementioned abrasive materials!**

### Example

Abrasive	Grain	Hardness	Structure	Bond	Remark
517A	54/11	202	G/H	V341	
Mixture of monocrystalline and special fused aluminium oxide	Combination of size of the abrasive grain and other sizes	Soft grinding hardness for optimal self-sharpening	Open and highly porous for improved cooling performance	Vitreous bond	For flat surface grinding of soft and hardened steels

Talk to us to find out about our complex range of products, tailor-made solutions and exclusive high-tech products:

- 3A, 5A** The winner amongst sintered aluminium oxide grinding wheels
- 56A** A new star amongst special fused aluminium oxides
- 517A/518A** Our universal grinding wheel
- 519A** Low-cost sintered aluminium oxide grinding wheel
- B9** The best bond for rail grinding

# Product range

In addition to the mentioned sizes, we can also produce special sizes to your specifications within four weeks!

Flat surface grinding	Internal grinding	Cylindrical grinding	Gear and thread grinding	Tool grinding
Saw sharpening	Rough grinding	Rail grinding	Specification	



Diameter	Width	Hole
225	20, 25	32, 50, 8, 76, (2)
250	13, 16, 20, 25	50, 8, 76, (2)
300	13, 16, 20, 25, 32, 40, 50	76, (2), 127
350	16, 20, 25, 32, 40, 50	76, (2), 127
400	20, 25, 32, 40, 50, 63, 80, 100	127, 203, 2
450	20, 25, 32, 40, 50, 63, 80, 100	127, 203, 2
500	25	203, 2
500	32, 40, 50, 63, 80, 100	203, 2, 304, 8
600	32, 40, 50, 63, 80, 100, 125	203, 2, 304, 8
750	30 - 125	304, 8
800	31 - 125	304, 8
900	32 - 125	304, 8
1060	32 - 160	304, 8



Diameter	Width (recess)	Hole
10	10	4
13	13 (6x6)	4
16	16 (10x4)	6
20	20 (13x8)	6
25	16 (16x6)	10
25	25 (16x10)	10
32	20 (16x8)	10
32	32 (16x12)	10
40	25 (20x10)	13
40	32	13
40	40 (20x15)	13
50	32	20
50	40 (32x15)	20

All recesses optional!



Diameter	Width	Hole
225	20, 25	32, 50, 8, 76, 2
250	13, 16, 20, 25	50, 8, 76, 2
300	13, 16, 20, 25, 32, 40, 50	76, 2, 127
350	16, 20, 25, 32, 40, 50	76, 2, 127
400	20, 25, 32, 40, 50, 63, 80, 100	127, 203, 2
450	20, 25, 32, 40, 50, 63, 80, 100	127, 203, 2
500	25	203, 2
500	32, 40, 50, 63, 80, 100	203, 2, 304, 8
600	32, 40, 50, 63, 80, 100, 125	203, 2, 304, 8
750	30 - 125	304, 8
800	31 - 125	304, 8
900	32 - 125	304, 8
1060	32 - 160	304, 8



Reishauer		
Diameter	Width	Hole
350	62, 84, 104	160
400	84, 104	160

with div. modules, 1 or 2-thread

Pfauder Kapp, Hoefler Niles, Reform, Samputensili		
Diameter	Width	Hole
350	25 - 63	127
400	25 - 63	127, 203, 2
450	25 - 63	127, 203, 2

Thread grinding		
Diameter	Width	Hole
350	8 - 16	160

Type 1 - straight		
Outside-Ø	Thickness	Hole
125	20	32
150	20, 25	32
175	20, 25, 32	32, 51
200	20, 25, 32	32, 51
250	32	32, 51
300	40	32, 51, 76

Type 6 - DIN D		
Diameter	Width	Hole
80	40	20
100	50	20
125	63	20, 32
150	80	20, 32

Type 11 - DIN E		
Diameter	Width	Hole
100	35, 40	20
125	40, 45	20, 32
150	50	20, 32

Type 12 - DIN B		
Diameter	Width	Hole
80	8	20
100	12	20, 32
125	14	20, 32
150	15	20, 32

Chain saws		
Diameter	Width	Hole
140 - 150	3 - 4, 8	16, 20, 25, 32

Circular saws, band saws		
Diameter	Width	Hole
150, 200, 250	1 - 16	20, 25, 32

Resinoid		
Diameter	Width	Hole
150, 200, 250	1 - 14	20, 25, 32
300	10 - 14	32, 40

Diameter	Width	Hole
225	20, 25	32, 50, 8, 76, (2)
250	13, 16, 20, 25	50, 8, 76, (2)
300	13, 16, 20, 25, 32, 40, 50	76, (2), 127
350	16, 20, 25, 32, 40, 50	76, (2), 127
400	20, 25, 32, 40, 50, 63, 80, 100	127, 203, 2
450	20, 25, 32, 40, 50, 63, 80, 100	127, 203, 2
500	25	203, 2
500	32, 40, 50, 63, 80, 100	203, 2, 304, 8
600	32, 40, 50, 63, 80, 100, 125	203, 2, 304, 8
750	30 - 125	304, 8
800	31 - 125	304, 8
900	32 - 125	304, 8
1060	32 - 160	304, 8

Diameter	Width (recess)	Hole
110/90	55 (HT110)	22, 2
125	60 (with 4 threads M8)	55
125	65 (with centre thread M20)	M20 R/L
135	90 (recess 55x30)	25, 5
150	60 (with centre thread M20)	M20 R/L
150	65 (with 4 threads M8)	80
150	70 (with centre thread M20)	M20 R/L
200	80 (with 4 threads M8)	130
230	20, 23, 25, 30	25
250	20	25, 4
254	32 (with recesses)	25, 4
260	25	120
300	40	120

